

SHAFTESBURYS
BLINDS // SHUTTERS

ROMAN BLINDS SPECIFICATION, MEASURING & FITTING GUIDE



ROMAN BLINDS

OPTIONS

Blind Types:

Standard Roman - Cord Cleat System
Deluxe Roman - Sidewinder Operation

Fabrics:

The Roman Blinds Collection. (see index sheet)

Standard Cleat Colours:

Available with Standard Roman Blinds only.
Choose between brass, chrome or black.

Standard/Deluxe Blinds:

Minimum Width: 350mm

Minimum Drop: 400mm

The minimum width must be taken as an exact measurement (ordering recess will take it under the minimum size allowed).

Maximum standard width: 1320mm

Maximum Drop: 2500mm

Maximum extended width: 2500mm (with join)

Maximum Drop: 2000mm

For blinds up to 1320mm width the maximum drop allowed is 2500mm.
For blinds with an extended width over 1320mm the drop is reduced from 2500mm to 2000mm. This is due to the amount of fabric the headrail can withstand.

Individual fabric widths determine where a join is required. Please refer to individual fabrics for maximum single blind widths without a join.

FEATURES

Steel or Aluminium Headrail

White only. Strong, lightweight.

Cord Cleat System or Sidewinder Operation

Easy to fit and use.

Fabric attached to headrail with Velcro

Fabric is easily removable from headrail for Dry Cleaning.

Fully Lined Fabric

Protects fabric from direct sunlight.

Choice of Standard or Deluxe System

IMPORTANT

Customers should be aware of the following manufacturing limitations before ordering.

- 1** Because of colour variations between product batches we cannot always guarantee shade matching.
- 2** Due to the inherent nature of some fabrics and the restrictions of the manufacturing process, the straightness of the horizontal design cannot be guaranteed.
- 3** Due to the print design of some fabrics, it is not guaranteed that the pattern will always be symmetrical from the centre of the blind.

Generally the panel depths of Romans ordered for adjacent windows with different drops will not match each other. See 'Same room option' for more information.

ROMAN BLINDS

STANDARD

PARTS IDENTIFICATION

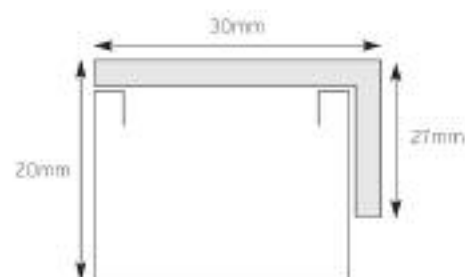
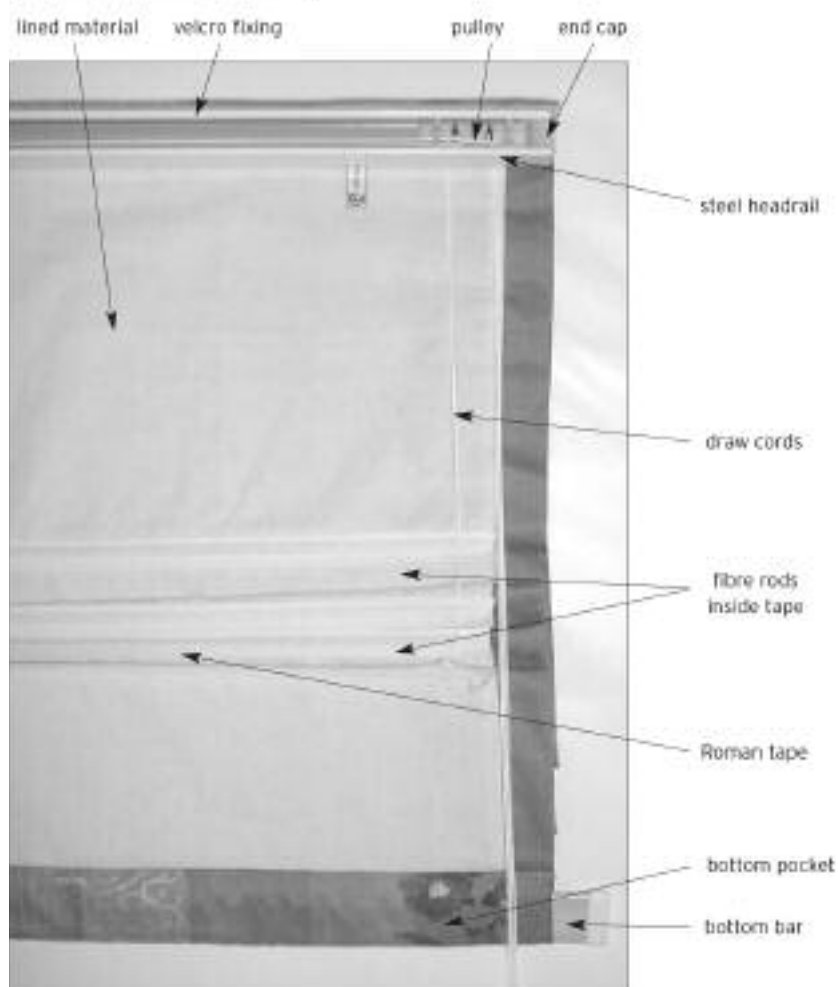

STANDARD HEADRAIL

All dimensions are inclusive of brackets.



CLEATS

Available in Black, chrome and brass.

ROMAN BLINDS

DELUXE

PARTS IDENTIFICATION

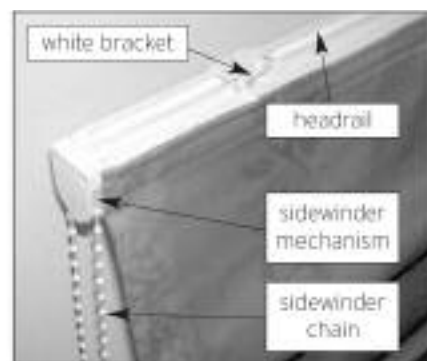
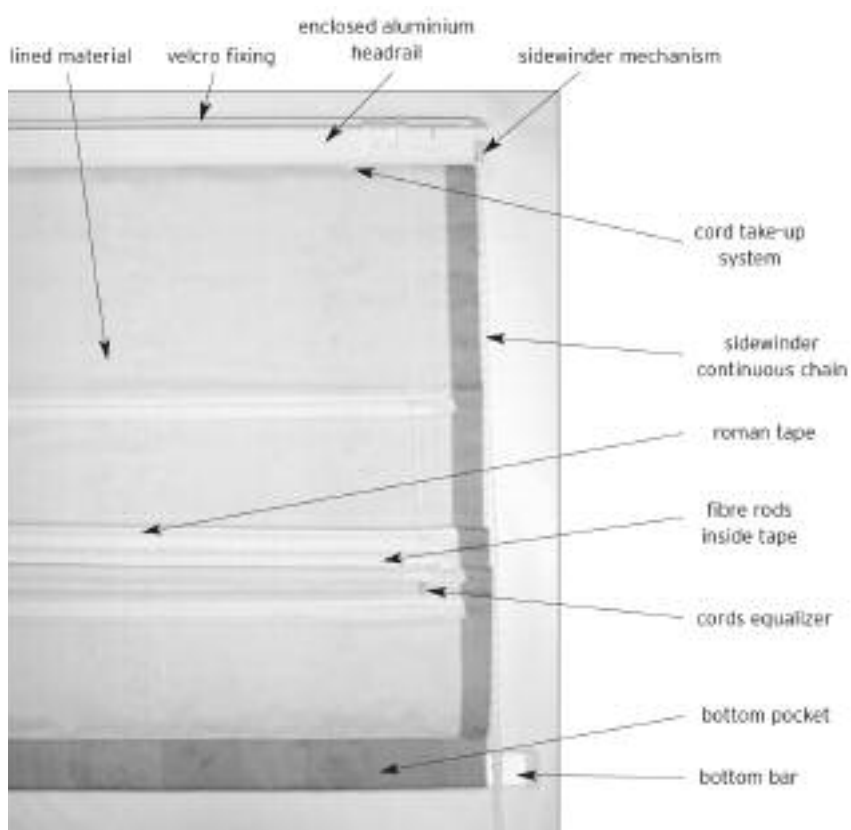

PLEASE NOTE:

Roman blind fabric gives full coverage of the rail.

The fabric illustrated here has been moved to avoid obscuring full view of the sidewinder mechanism.

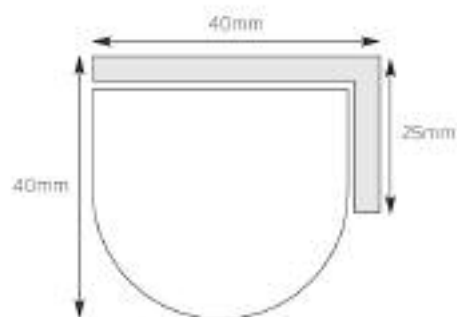

DELUXE HEADRAIL

All dimensions are inclusive of brackets.

BLACKOUT ROMAN BLINDS

OPTIONS

Blind Types:

A selection of fabrics from the Roman Blinds Collection.

Deluxe Blinds:

Minimum Width: 350mm

Minimum Drop: 400mm

The minimum width must be taken as an exact measurement (ordering recess will take it under the minimum size allowed).

Maximum width: 2000mm

Maximum Drop: 2000mm

Individual fabric widths determine where a join is required. Please refer to individual fabrics for maximum single blind widths without a join.

FEATURES

Steel or Aluminium Headrail

White only. Strong, lightweight.

Sidewinder Operation.

Easy to fit and use.

Fabric attached to headrail with Velcro

Fabric is easily removable from headrail for Dry Cleaning.

Fully lined with blackout fabric.

Protects fabric from direct sunlight and blocks out light.

Deluxe System

IMPORTANT

The lining is attached 15mm from the edge of the blind where the face fabric is turned in, therefore the edge of the blind will not give total blackout.

When ordering BLACKOUT lining for Roman Blinds the following limitations apply:

1. Blackout lining is only compatible with the deluxe head rail system i.e. you cannot have blackout with a standard cleat system.
2. The absolute maximum width for blinds with blackout lining is 2000mm, there can be no joins because of 'pin holes' allowing light filtration.

BLACKOUT ROMAN BLINDS

DELUXE

PARTS IDENTIFICATION

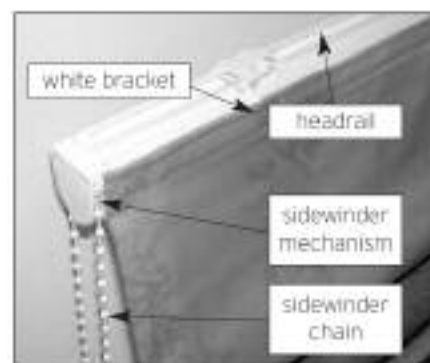
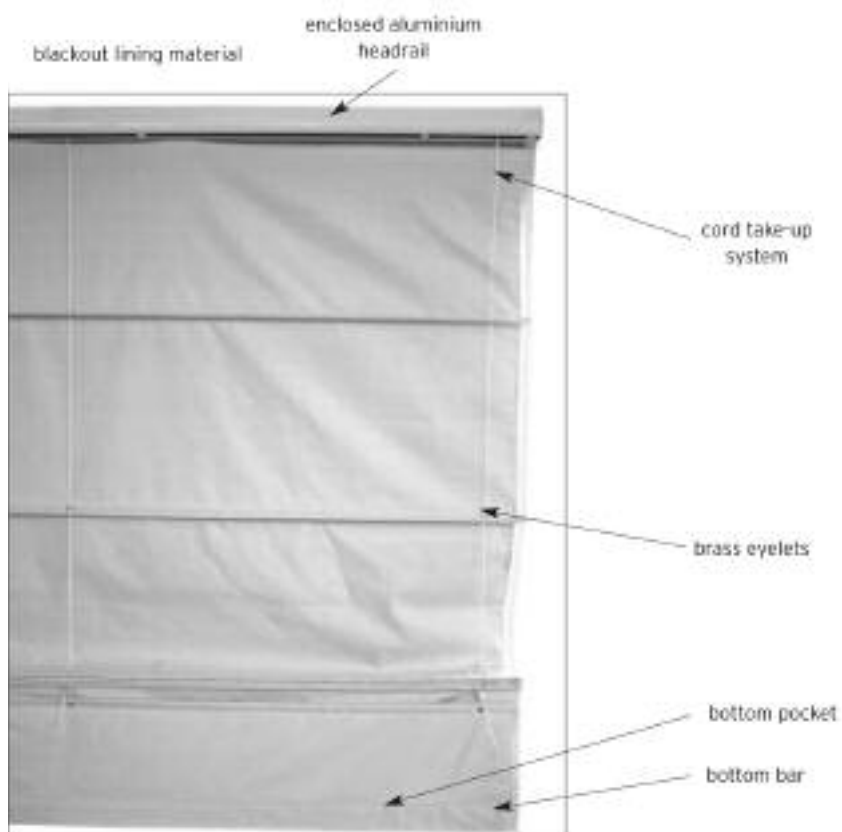

PLEASE NOTE:

Roman blind fabric gives full coverage of the rail.

The fabric illustrated here has been moved to avoid obscuring full view of the sidewinder mechanism.

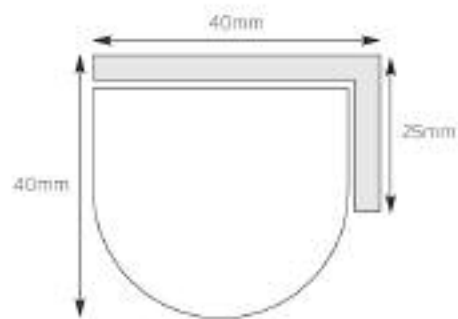

DELUXE HEADRAIL

All dimensions are inclusive of brackets.

JOIN INFORMATION

ROMAN BLINDS

The maximum width of a blind without a join is determined by the fabric width.
Note: See your index sheet for maximum single blind widths.

Joining patterned fabrics

Patterned fabric blinds are joined in two ways, the most aesthetically pleasing way is to have two side seam joins. This is done if the overall blind width is more than 280mm wider than the fabric width. Other joined blinds will have a centre seam.
See diagram below.

Joining plain fabrics

Blinds wider than the fabric width will be made with side joins.

Note: If a centre join is preferred, this can be done as long as the request is written in the 'Special Instructions' box on the order form.

Note: For wide windows we would recommend ordering two blinds. This looks better, is easier to operate and is better at controlling the light.

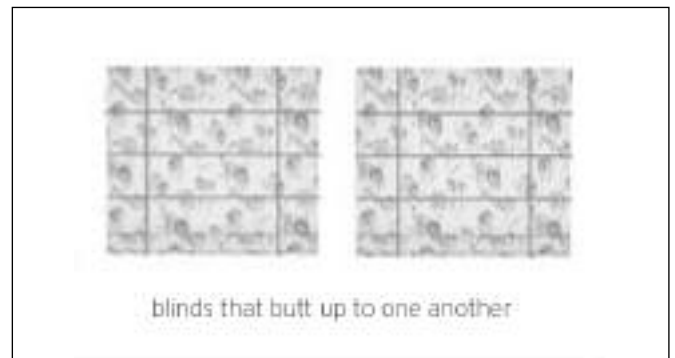
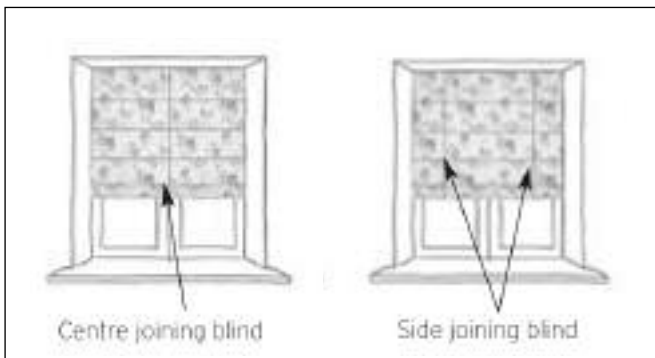

SAME ROOM OPTION

ROMAN BLINDS

When to request 'same room option'

Same room option determines the way we match the panel lengths for blinds that are to be hung side by side. eg. in a conservatory, when the panel lengths match and the waterfalls of fabric hang neatly side by side.

On Roman blinds the pattern will always be matched at the top of each blind.

This is what happens to all blinds when ordered as same room option:

- 1** If one of the blinds requires a centre join all blinds will be joined in the same way.
- 2** Blinds with joins will be pattern matched at the seams.
- 3** Panels on blinds with varying drops up to 40mm of (greater than) the shortest blind will be matched to each other. Blinds with drops more than 40mm longer than the shortest blind cannot be panel matched.

Panel matching

When multiple blinds are on the same order (same room option) the manufacturing system looks at the drop of the shortest blind to create the panel drops.

Blinds with the same drop will be panel matched to it.

Blinds with varying drops up to 40mm longer than the shortest blind will be panel matched to it.*

Note: you should be aware that the difference in length will be added to the last panel. this means that when the blinds are fully drawn the tail of the blinds will vary in length, however the waterfall of the fabric will match across the blinds.

All other blinds on the order will not have matching panel drops.

We are not able to automatically panel match more than one group of blinds to each other within an order even if there are different fabrics for other rooms within the order.

We would recommend:

Roman blinds for different rooms or fabrics should always be on separate orders so they can be matched with each other.

Where multiple blinds are required for a conservatory you may not want to panel match the door blind. Simply do not set the 'same room option' flag for this blind.

SAME ROOM OPTION

ROMAN BLINDS

Panel matching with varying tail lengths

1200mm drop

1210mm drop

1220mm drop

1250mm drop

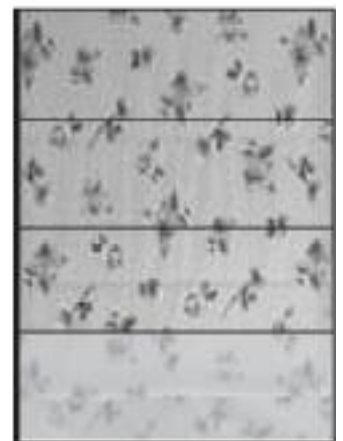
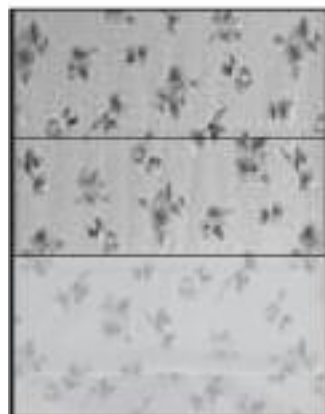
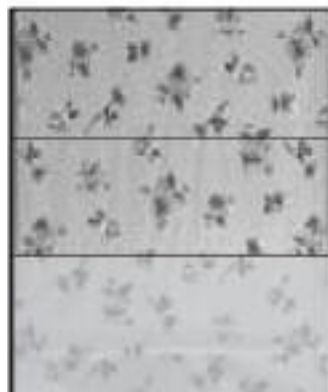
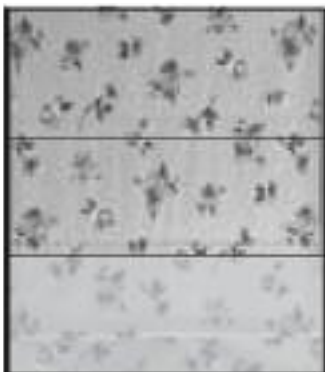

Panels match across blinds where drop is within 40mm of each other. However the difference in length will be added to the last panel

Panels do not match where drop is 40mm greater than the shortest blind on the order

MEASURING GUIDE

ROMAN BLINDS

RECESS

For blinds to hang inside the window recess:

Measure the drop by taking the measurement from the top of the recess to the window sill, in three places as shown. Measure the width of the window recess from wall to wall, in three places as shown. Take the smallest measurement.

We will deduct 5mm from each side i.e. 10mm in total to ensure your blinds fit perfectly.



MEASURING INSTRUCTIONS

For accurate measurements please use a metal tape measure, and take measurements in centimetres, to the nearest 1mm.

All of our blinds can be fixed into the face of the window frame or wall, or into the top of the lintel - allowing you total control of the depth your blind can be positioned in the depth of your window recess.

Choose whether you want the blinds to hang inside or outside the window recess.

Please check for the proximity of adjacent walls, furniture, window handles etc. when measuring for your blinds.

EXACT

For blinds to hang outside the window recess:

Measure the exact area you would like the blind to cover as shown.

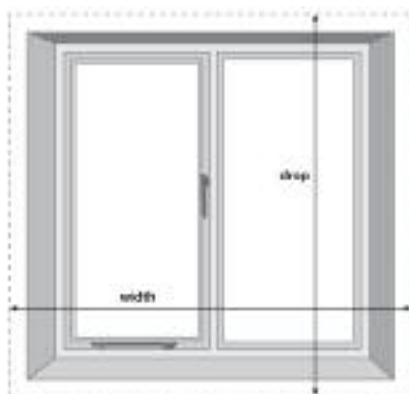

MEASURING GUIDE

ROMAN BLINDS

STACKING HEIGHT

The following details are for guidance only, but do represent the approximate stacking height of Roman blinds at various drops.

Drop	Stack
blinds up to 440mm	approx 180mm
between 440mm and 720mm	approx 200mm
between 720mm and 1000mm	approx 220mm
between 1000mm and 1280mm	approx 230mm
between 1280mm and 1560mm	approx 250mm
between 1560mm and 1840mm	approx 270mm
between 1840mm and 2130mm	approx 290mm
between 2130mm and 2500mm	approx 310mm

AFTERCARE

Look after your blinds by following the straightforward operating instructions below.

Operating Instructions

- Pull the cords to raise the blind to the desired level.
- Then tie the cord around the cleat (if fitting Standard Roman blind).

Cleaning

- The fabric can be removed from the headrail and the rods removed, but should be dry cleaned with care. (P)
- Soft fabric will shrink - if any of the fibre rods become visible trim off to the desired length with an appropriate tool.
- As an alternative to dry cleaning, the blind can be cleaned using the upholstery tool on your vacuum cleaner.

FITTING GUIDE

ROMAN BLINDS

FITTING

1 Use universal top fix/face fix bracket for all fitting requirements.

Please note: the brackets supplied with a standard Roman are silver and those supplied with a deluxe Roman are white. The two brackets differ in size.

2 To fit the brackets for a Standard Roman blind leave a 70mm clearance at either end of the rail to prevent interference with cord supports. Always ensure brackets are evenly spaced across the headrail.

3 To fit the brackets for a Deluxe Roman blind leave a 30mm clearance at either end of the rail to prevent interference with the control mechanism. Always ensure brackets are evenly spaced across the headrail.

4 For a Standard Roman blind only, establish the fitting position for Cord Cleat (usually one third up from the window sill) and fix using screws provided.

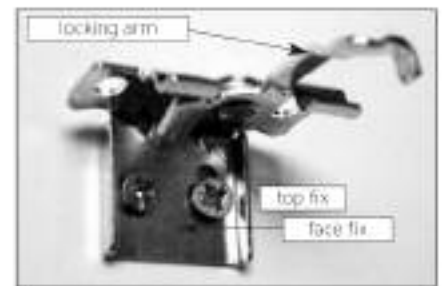

FITTING GUIDE

ROMAN BLINDS

STEP 1

Outside Recess

If fitting the blind outside the window, measurements **(C)** will need to be the same. To work out **(C)**, simply minus **(B)** from **(A)** and divide the answer by two. Follow instructions for FACE FIXING.



Inside Recess

Decide whether to FACE or TOP FIX. FACE FIX to fit the bracket to the window frame. TOP FIX to the lintel if the window frame is uPVC, or if there are any obstructions, eg. window handles.

STEP 2

Place blind in fitting position. The two brackets differ in size. To fit the brackets for a Standard Roman blind leave a 70mm clearance at either end of the rail to prevent interference with cord supports. To fit the brackets for a Deluxe Roman blind leave a 30mm clearance at either end of the rail to prevent interference with control mechanism. Always ensure brackets are evenly spaced across the headrail.



STEP 3

Top Fixing

Measure the distance that any handles protrude from the frame, **A**. Mark this measurement on the lintel and use it to position the back of the bracket. Mark the position of holes **B** and screw bracket to lintel using screws and rawl plugs supplied.

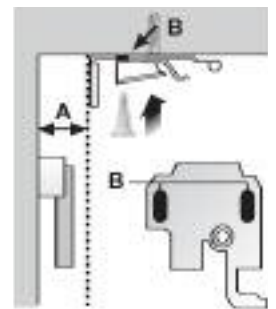

Face Fixing

Position bracket with swing arm facing towards you, and mark holes **B**. Screw bracket in place. Use rawl plugs if fitting to the wall.



STEP 4

Push swing arm anti-clockwise as far as it will go. Now clip the blind over the bracket, first easing the front lip of the headrail **A** in to place.

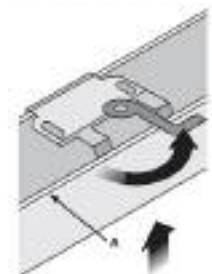

Push swing arm clockwise until it locks in to place, firmly holding the blind headrail.

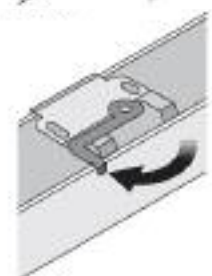

FITTING GUIDE

ROMAN BLINDS

STEP 5

Standard Romans Only

Fix the cleat to the frame or wall in an easy-access position. Screw cleat into place using the screws supplied.

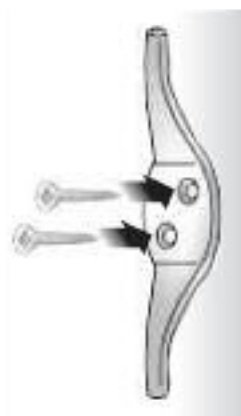

STEP 6

The fabric of the Roman blind attaches to the headrail with Velcro.

Standard Romans Only

Pull side cords to open the blind, and tie them to the cleat to keep the blind raised.



WARNING

IN THE INTEREST OF SAFETY, IT IS ADVISABLE TO KEEP ALL PULL CORDS AND CHAIN/BEAD CORDS OUT OF THE REACH OF CHILDREN.